

# FIELDKING

Complete farm mechanization solution



97 Countries



1.2 million farmers



1400 Dealers



## BERI UDYOG PVT LTD

Corporate Office:

Plot No. 235-236 & 238-240, Sec-3,  
HSIIDC, Karnal- 132001 (Haryana), India

+91 184 2221571/ 72/ 73

info@fieldking.com

Sales & Marketing Office (Exports):

DGL 221, 2nd Floor, The Galleria,  
Mayur Vihar, Phase-1, Delhi, India

+91 11 48042089

exports@fieldking.com www.fieldking.com

Our world revolves around innovative farming solutions & excellent customer support

Sr. No.	Particulars	Page	No.
1.	MD's Desk		2
2.	Infrastructure		3-4
3.	Corporate Clients		5
4.	Exhibitions & Trade Shows		6
5.	Presence Across The Globe		7
6.	Product Portfolio		8
7.	Tillage		9-40
	• Rotary Tiller		
	• Power Harrow		
	• Disc Harrow		
	• Plough		
	• Multi Row Tiller		
	• Ripper		
	• Sub Soiler		
	• Cultivator		
	• Tyne Ridger		
	• Disc Ridger		
8.	Haulage		41-44
	• Trailer		
9.	Landscaping		45-48
	• Leveler		
	• Rotary Slasher		
	• Rotary Cutter		
10.	Seeding & Plantation		49-52
	• Post Hole Digger		
	• Disc Seed Drill		
	• Multi Crop Row Planter		
	• Pneumatic Planter		
11.	Crop Protection		53-54
	• Tractor Mounted Boom Sprayer		
	• Fertilizer Spreader		
12.	Harvest & Post Harvest		55-61
	• Reciprocating Forage Mower		
	• Sugar Cane Loader		
	• Square Baler		
	• Combine Harvester		
	• Hay Rake		
13.	Other Popular Products		62
14.	Marketing Footprints		63-64
15.	360° Sales & Marketing Support		65



**Managing Director  
(Mr. Ravi Beri)**

## From The Managing Director's Desk

 **VISION** to build an organization that relentlessly adds value in what it does (i.e. products) and for whom it does (i.e. customers) & through whom it does (i.e. employees).

 **MISSION** to be a front runner in offering innovative, user friendly & environmentally sustainable farming solutions to farmers around the globe.

In accomplishing our vision and mission our suppliers, channel partners, corporate clients and our work force play a key role and are accorded with respect and recognition as they make us who we are and who we aspire to be.





3 Manufacturing facilities



Area 162000 sqm.



Modernized Assembly Line



Robotics



Conveyorized Paint Shop



Cutting Centers



Machining Centers





Certified To International Quality Standards



USA



USA



EIMA, ITALY



SIMA, PARIS



AGRITECHNICA, GERMANY



BANGKOK



SOUTH AFRICA



SRI LANKA



BANGLADESH



FIELDKING continues to grow in markets across the globe. This ever increasing demand is a result of continuous value addition. We have sold more than one million equipment around the globe. Our brand name "FIELDKING" is a distinguished name in overseas markets. Company's association with overseas markets is in reach of 97 countries across the globe.



97 Countries



1.2 million farmers



1400 Dealers

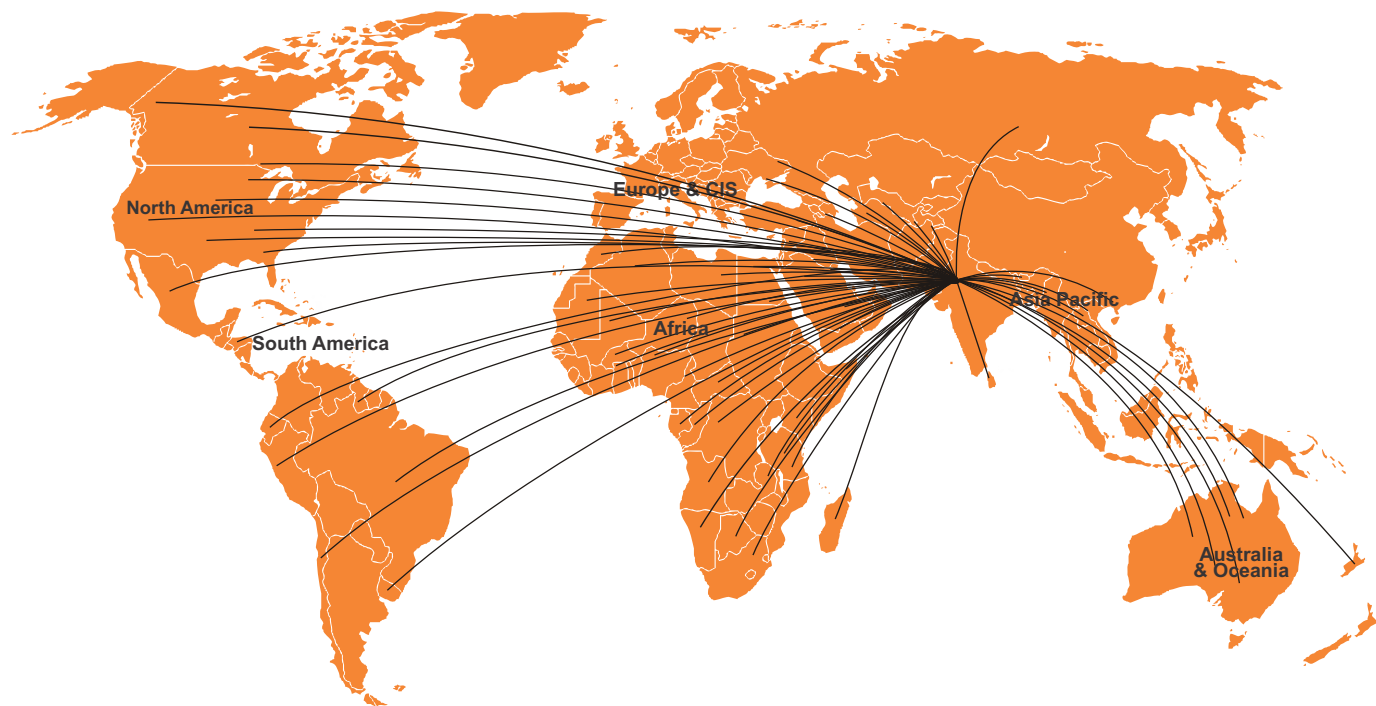

Tillage



Haulage



Landscaping



Seeding & Plantation



Crop Protection



Harvest



Post Harvest







Tillage

DESCRIPTION	FKDRTSG-125	FKDRTSG-150	FKDRTSG-175	FKDRTSG-200	FKDRTSG-225
Tillage Width (cm)	125	150	175	200	225
Gear Box	Single Speed (540 RPM)				
Type of Blades	L / C / J				
No. of Blade	30/ 30/ 48	36/ 36/ 60	42/ 42/ 72	48/ 48/ 84	54/ 54/ 96
Weight (Kg. Approx.)	420	450	480	510	540
Tractor Power (HP)	35-40	40-45	45-50	50-60	60-70

\*Different rpm can be achieved by using different side gear ratio i.e. 194 rpm with 18:33:28 & 230 rpm with 19:33:25  
For more information visit [www.fieldking.com](http://www.fieldking.com)







Tillage

DESCRIPTION	FKDRTMG-175	FKDRTMG-200	FKDRTMG-225	FKDRTMG-250	FKDRTMG-275
Tillage Width (cm)	175	200	225	250	275
Gear Box	Multi (4 Speed)				
Type of Blades	L / C / J				
No. of Blade	42/ 42/ 72	48/ 48/ 84	54/ 54/ 96	60/ 60/ 108	66/ 66/ 120
Weight (Kg. Approx.)	510	540	570	600	630
Tractor Power (HP)	45-50	50-60	60-70	70-80	80-90

P.T.O RPM	ROTOR R.P.M (C/D)	
	A	B
540	20	16
	16	20
	17	19
	19	17
1000	22	14

\*Rotor r.p.m with individual gear drive denoted by C/D represents 18:33:28/19:33:25 respectively. For more information visit [www.fieldking.com](http://www.fieldking.com)

DESCRIPTION	FKRTSG-100	FKRTSG-125	FKRTSG-150	FKRTSG-175	FKRTSG-200
Tillage Width (cm)	100	125	150	175	200
Gear Box	Single Speed (11 x 20)				
Type of Blades	L / C / J				
No. of Blade	24/ 24/ 36	30/ 30/ 48	36/ 36/ 60	42/ 42/ 72	48/ 48/ 84
Weight (Kg. Approx.)	350	380	410	440	470
Tractor Power (HP)	25-35	35-40	40-45	45-50	50-60

\*Different rpm can be achieved by using different side gear ratio i.e. 190 rpm with 18:33:28 & 225 rpm with 19:33:25. For more information visit [www.fieldking.com](http://www.fieldking.com)







Tillage  
1

DESCRIPTION	FKRTMG-100	FKRTMG-125	FKRTMG-150	FKRTMG-175	FKRTMG-200
Tillage Width (cm)	100	125	150	175	200
Gear Box	Multi (4 Speed)				
Type of Blades	L / C / J				
No. of Blade	24/ 24/ 36	30/ 30/ 48	36/ 36/ 60	42/ 42/ 72	48/ 48/ 84
Weight (Kg. Approx.)	380	410	440	470	500
Tractor Power (HP)	25-35	35-40	40-45	45-50	50-60

P.T.O RPM	ROTOR R.P.M (C/D)		
	A	B	
540	20	16	144/170
	16	20	225/266
	17	19	201/238
	19	17	161/190
1000	22	14	212/251

\*Rotor r.p.m with individual gear drive denoted by C/D represents 18:33:28 / 19:33:25 respectively. For more information visit [www.fieldking.com](http://www.fieldking.com)

DESCRIPTION	BRTMG 145	BRTMG 165	BRTMG 185	BRTMG 205
Tillage Width (cm)	145	165	185	205
Gear Box	Multi (2 Speed)			
Type of Blades	L & C			
No. of Blade	42	48	54	60
Weight (Kg. Approx.)	340	360	380	400
Tractor Power (HP)	35-40	40-45	45-50	50-60

\*Rotor r.p.m with individual gear drive denoted by C/D represents 18:33:28/19:33:25 respectively. For more information visit [www.fieldking.com](http://www.fieldking.com)





## Hobby Rotary Tiller



DESCRIPTION	FKRTMSC- 80	FKRTMSC-100	FKRTMSC-120	FKRTHSC-140	FKRTHSC-160	FKRTHSC-180
Tillage Width (cm)	80	100	120	140	160	180
Gear Box (rpm)	Single Speed (15x22)			Single Speed (11x20)		
Type of Blades	Small L & C					
No. of Blade	24	30	36	42	48	54
Weight (Kg. Approx.)	170	187	203	236	258	279
Tractor Power (HP)	15-20	20-25	25-30	30-35	35-40	40-45

For more information visit [www.fieldking.com](http://www.fieldking.com)



## Power Harrow



DESCRIPTION	FKRPH-5	FKRPH-6	FKRPH-7	FKRPH-9	FKRPH-11
Cutting Width (m)	1.2	1.45	1.7	2.1	2.6
PTO Rpm / Rotor Rpm	Single Speed (540 / 302)				
No. of Rotor	5	6	7	9	11
No. of Blades	10	12	14	18	22
Blades Thickness (mm)	14				
Gear Box Overload Protection	Shear Bolt				
Weight With Crumbler (Kg. Approx.)	450	550	650	800	950
Tractor Power (HP)	40-45	45-60	60-75	75-100	100-125

For more information visit [www.fieldking.com](http://www.fieldking.com)







DESCRIPTION	FKMDHC-22-12	FKMDHC-22-16	FKMDHC-22-20	FKMDHC-22-24	FKMDHC-22-28
No. of Disc	12	16	20	24	28
Width of Cut (mm Approx.)	1500	2000	2500	3000	3500
Disc to Disc Spacing (mm)			250		
Weight (Kg. Approx.)	740	1035	1330	1625 / 1725	1920 / 1974
Tractor Power (HP)	45-55	55-65	65-90	90-120	120-150

For more information visit [www.fieldking.com](http://www.fieldking.com)





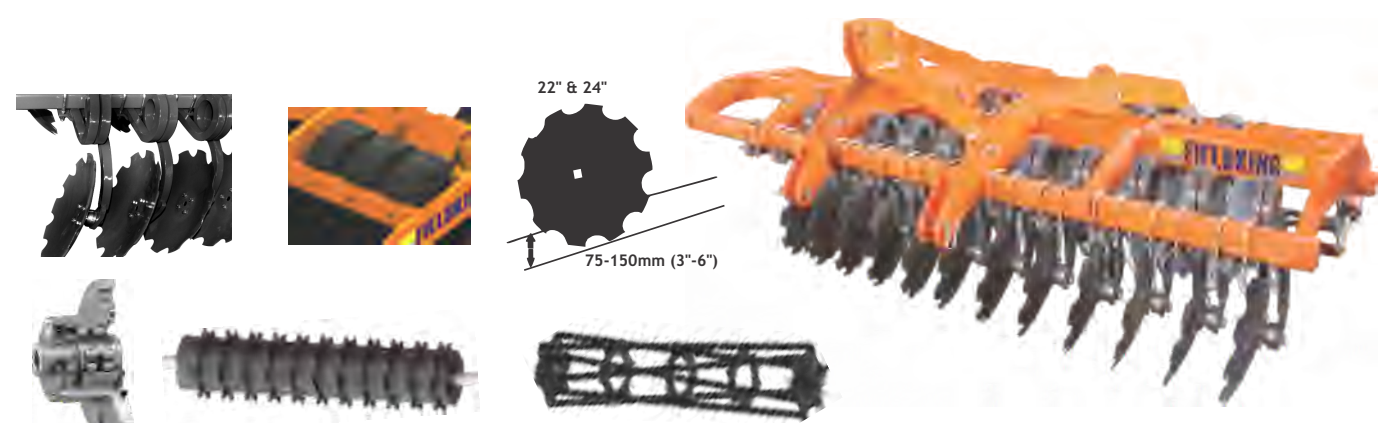

DESCRIPTION	FKMDHDCT-22-12	FKMDHDCT-22-16	FKMDHDCT-22-20	FKMDHDCT-22-24	FKMDHDCT-22-28
No. of Disc	12	16	20	24	28
Width of Cut (mm Approx.)	1498	2000	2500	3000	3500
Disc to Disc Spacing (mm)			250		
Weight (Kg. Approx.)	808	1125	1442	1759 / 1859	2076 / 2130
Tractor Power (HP)	45-55	55-65	65-90	90-120	120-150

For more information visit [www.fieldking.com](http://www.fieldking.com)











DESCRIPTION	FKUSDHH - 24	FKUSDHH - 28	FKUSDHH - 32	FKUSDHH - 36
No. of Disc 	24	28	32	36
Width of Cut (mm Approx.) 	3118	3658	4198	4738
Disc to Disc Spacing (mm) 				
Weight With Crumbler (Kg. Approx.) 	3379	3942	4505	5068
Tractor Power (HP) 	125-140*	145-165*	170-200*	210-235*

\*Due to additional dead weight extra heavy duty hydraulic harrow operates on higher range of tractor (HP)  
For more information visit [www.fieldking.com](http://www.fieldking.com)



DESCRIPTION	FKHDHH-18	FKHDHH-20	FKHDHH-22	FKHDHH-24	FKHDHH-28	FKHDHH-32
No. of Disc 	18	20	22	24	28	32
Width of Cut (mm Approx.) 	2100	2300	2500	2700	3100	3500
Disc to Disc Spacing (mm) 			228			
Weight (Kg. Approx.) 	1540	1630	1760	1845	2015	2170
Tractor Power (HP) 	70-80	80-90	90-110	115-135	140-165	170-190

For more information visit [www.fieldking.com](http://www.fieldking.com)

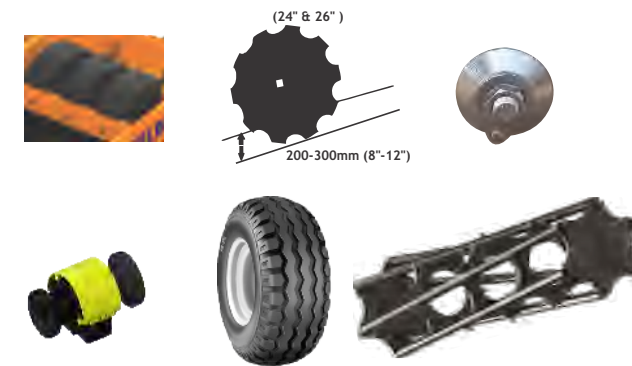





Tillage

DESCRIPTION	FKEHDHH-24	FKEHDHH-28	FKEHDHH-32	FKEHDHH-36
No. of Disc	24	28	32	36
Width of Cut (mm Approx.)	2700	3100	3500	3900
Disc to Disc Spacing (mm)	228			
With Dead Weight (Kg. Approx.)	3174*	3306*	3458*	3650*
Tractor Power (HP)	125-140*	145-165*	170-200*	210-235*

\*Due to additional dead weight extra heavy duty hydraulic harrow operates on higher range of tractor (HP)  
For more information visit [www.fieldking.com](http://www.fieldking.com)

DESCRIPTION	FKMODH-12	FKMODH-14	FKMODH-16	FKMODH-18	FKMODH-20	FKMODH-22	FKMODH-24
No. of Disc	12	14	16	18	20	22	24
Width of Cut (mm Approx.)	1420	1635	1852	2068	2285	2502	2718
Disc to Disc Spacing (mm)	228						
Weight (Kg. Approx.)	390	430	500	575	615	676	731
Tractor Power (HP)	30-40	40-50	50-60	60-70	70-80	80-90	90-100

For more information visit [www.fieldking.com](http://www.fieldking.com)

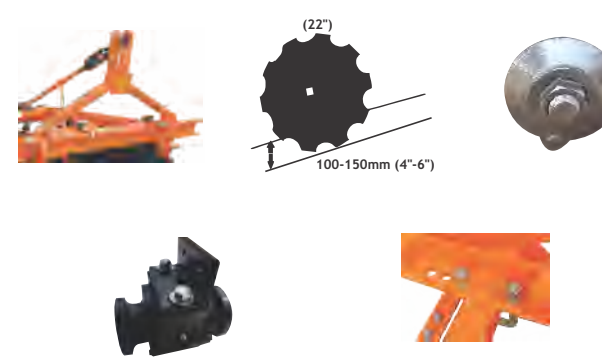
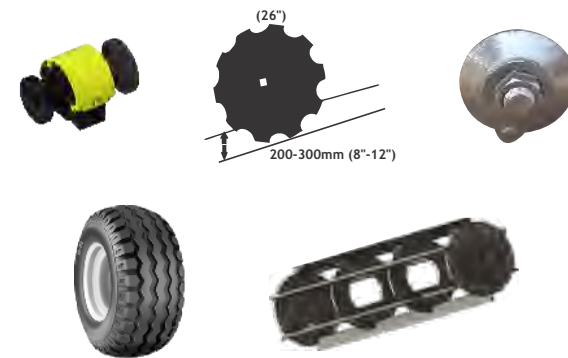





DESCRIPTION	FKCMDH-16	FKCMDH-18	FKCMDH-20	FKCMDH-22	FKCMDH-24
No. of Disc	16	18	20	22	24
Width of Cut (mm Approx.)	1912	2128	2345	2562	2778
Disc to Disc Spacing (mm)	228				
Weight (Kg. Approx.)	840	960	1025	1095	1170
Tractor Power (HP)	50-60	60-70	70-80	90-100	105-125

For more information visit [www.fieldking.com](http://www.fieldking.com)

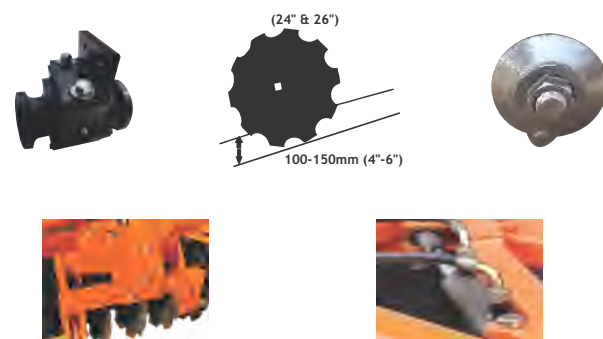

**Tandem Disc Harrow Light Series**

DESCRIPTION	FKTDHM-7.5-20	FKTDHM-7.5-24
No. of Disc	20	24
Width of Cut (mm Approx.)	1524	1889
Disc to Disc Spacing (mm)	228	
Weight (Kg. Approx.)	355	415
Tractor Power (HP)	45-50	55-65

For more information visit [www.fieldking.com](http://www.fieldking.com)



**Tandem Disc Harrow Medium Series**

DESCRIPTION	FKTDHMS-12	FKTDHMS-16	FKTDHMS-20
No. of Disc	12	16	20
Width of Cut (mm Approx.)	1415	1848	2280
Disc to Disc Spacing (mm)	228		
Weight (Kg. Approx.)	300	385	440
Tractor Power (HP)	25-30	35-40	45-50

For more information visit [www.fieldking.com](http://www.fieldking.com)



**Tandem Disc Harrow Heavy Series**

DESCRIPTION	FKTDHHS-20	FKTDHHS-24
No. of Disc	20	24
Width of Cut (mm Approx.)	2408	2842
Disc to Disc Spacing (mm)	228	
Weight (Kg. Approx.)	580	640
Tractor Power (HP)	55-65	75-90

For more information visit [www.fieldking.com](http://www.fieldking.com)







DESCRIPTION	FKPDH-6	FKPDH-7	FKPDH-8	FKPDH-9	FKPDH-10
No. of Disc	6	7	8	9	10
Width of Cut (mm Approx.)	1066	1284	1501	1718	1935
Disc to Disc Spacing (mm)			228		
Weight (Kg. Approx.)	387	416	445	490	525
Tractor Power (HP)	45-50	45-50	55-60	65-75	65-75

For more information visit [www.fieldking.com](http://www.fieldking.com)

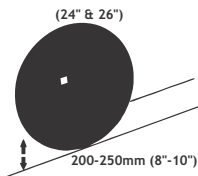

DESCRIPTION	FKRSPDH-6	FKRPDH-6	FKRPDH-7	FKRPDH-8
No. of Disc	6	6	7	8
Width of Cut (mm Approx.)	1453	1202	1453	1704
Disc to Disc Spacing (mm)	316		264	
Weight (Kg. Approx.)	527	510	550	600
Tractor Power (HP)	65-90	55-75	75-95	100-125

For more information visit [www.fieldking.com](http://www.fieldking.com)

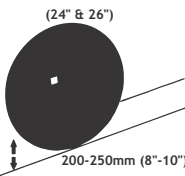





Tillage



Hexagonal heavy duty drawbar



Boron steel disc with scraper attachment



Optional model (3+1) bottom

DESCRIPTION	FKMDP-2	FKMDP-3	FKMDP-4	FKMDP-5
No. of Disc	2	3	4	5
Width of Cut (mm Approx.)	500 - 550	875 - 925	1150 - 1200	1575 - 1625
Disc to Disc Spacing (mm)	570			
Weight (Kg. Approx.)	310	415	510	620
Tractor Power (HP)	50-60	65-80	85-100	105-125

For more information visit [www.fieldking.com](http://www.fieldking.com)

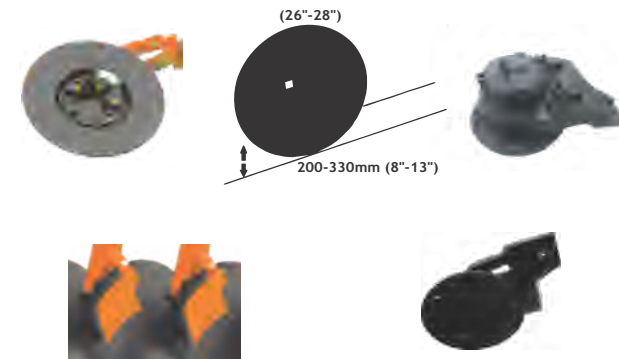









Tyre assembly for easy transportation



Long lasting, wear resistant boron steel blade



Turn buckle for adjusting of the plough

DESCRIPTION	FKRMBPH-36 - 2	FKRMBPH-36 - 3
Number of Furrow 	2	3 (2+1 Optional)
Width of Cut (mm Approx.) 	700	1050
Depth of Cut (Max. mm) 	355	
Weight (Kg. Approx.) 	460	635
Tractor Power (HP) 	55-70	75-100

For more information visit [www.fieldking.com](http://www.fieldking.com)



Rugged frame







Boron steel tynes with overload protection







DESCRIPTION	FKMBP36-2	FKMBP36-3	FKMBP36-4
Number of Furrow 	2	3	4
Width of Cut (mm Approx.) 	710	1010	1310
Depth of Cut (Max. mm) 		350	
Weight (Kg. Approx.) 	212 / 235	350	455
Tractor Power (HP) 	45-60	65-75	80-95

For more information visit [www.fieldking.com](http://www.fieldking.com)



Drawbar adjustment



Long lasting, wear resistant blade & bar point







Rugged frame



3 point linkage



DESCRIPTION	FKMRDCT -13	FKMRDCT -19
Length (mm) 	2374	3500
Crumbler Weight (Kg. Approx.) 	200	250
Weight Without Crumbler (30 x30 mm Sq. Tyne) (Kg. Approx.) 	560	800
Tractor Power (HP) 	65-90	90-120

For more information visit [www.fieldking.com](http://www.fieldking.com)



Double coil spring action tyne



Easy depth controller







DESCRIPTION	FKR- 5
Working Width (cm)	181
Working Depth (Max. mm)	400
Number of Tynes (Pcs.)	5
Weight Without Crumbler (Kg. Approx.)	495
Weight With Crumbler (Kg. Approx.)	852
Tractor Power (HP)	55-60 (4WD) / 60-65 (2WD)

For more information visit [www.fieldking.com](http://www.fieldking.com)



Sturdy 3 point linkage



Spiral crumbler



Special Design tyne with safety bolt



Tyne mounting clamp & shear bolt



DESCRIPTION	FKHDSS - 1	FKHDSS - 2	FKHDSS - 3
Working Width (mm)	70	800	1215
Working Depth (Max. mm)		700	
No. of Tyne	1	2	3
Weight (Kg. Approx.)	105	450	520
Tractor Power (HP)	40-65	60-75	90-115

For more information visit [www.fieldking.com](http://www.fieldking.com)



Crumbler (Optional)



Tyne & angle of attack



Replaceable tyne edge



Long lasting, wear resistant shoe & blade

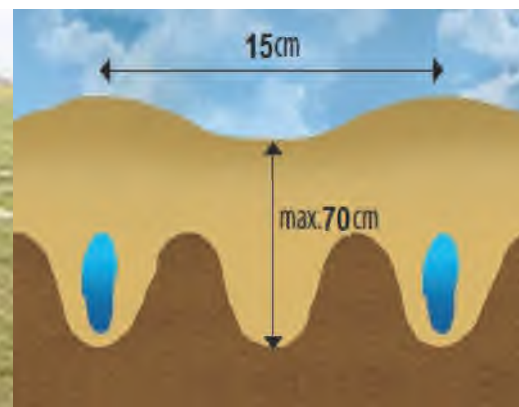





DESCRIPTION		FKSS-1	FKSS-2	FKSS-3	FKSS-5
Working Width (mm)		70	708-960	1055-1284	1810
No. of Tyne		1	2	3	5
Working Depth (Max. mm)			550		
Weight Without Crumbler (Kg. Approx.)		68	195	280	570
Weight With Crumbler (Kg. Approx.)		NA	245	430	790
Tractor Power (HP)		40-55	60-75	80-95	100-135

For more information visit [www.fieldking.com](http://www.fieldking.com)



Tillage

DESCRIPTION		FKDCT - 7	FKDCT - 9	FKDCT - 11	FKDCT - 13	FKDCT - 15	FKDCT - 21
Tynes (mm)				Sq. 25/ 30/ 35			Sq. 30/ 35
Width of Cut (mm)		1373	1830	2287	2744	3201	4610
Shovel to Shovel Distance				655 (mm)			900 (mm)
Weight (Kg. Approx.)		175/212/272	225/272/350	275/332/428	325/392/506	375/453/583	1167/985
Tractor Power (HP)		35-45	45-60	60-75	75-90	90-110	90-120

For more information visit [www.fieldking.com](http://www.fieldking.com)

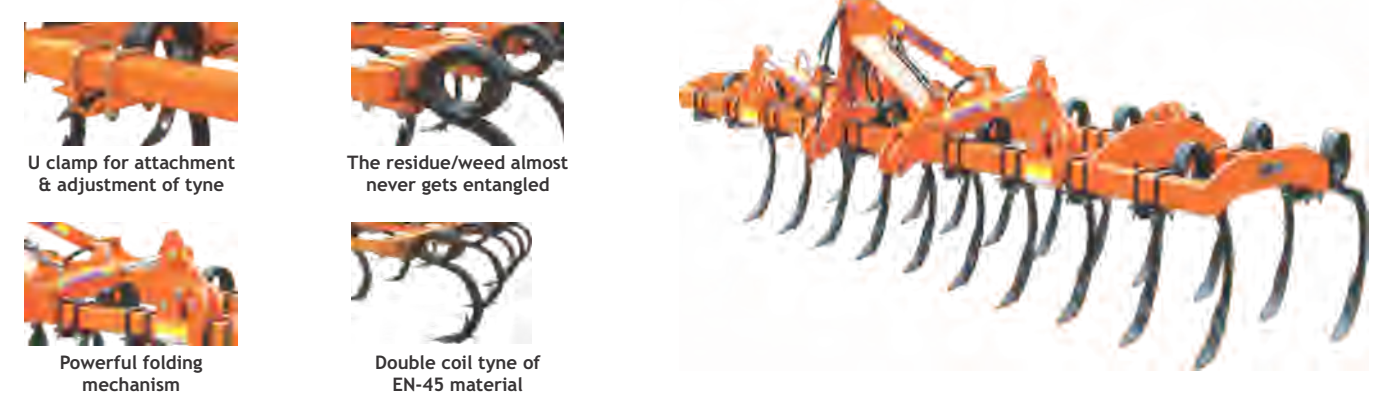





Tillage

DESCRIPTION	FKSLOEHD-5	FKSLOEHD-7	FKSLOEHD-9 / S-9	FKSLOEHD-11	FKSLOEHD-13	FKSLOEHD-15
Tynes (mm)	50 x 25 (Forged)					
Width of Cut (mm)	916	1373	1830	2287	2744	3201
Shovel to Shovel Distance (mm)	390					
Weight (Kg. Approx.)	130	180	270 / 285	345	405	480
Tractor Power (HP)	30-40	35-45	40-50	55-65	70-80	85-95

For more information visit [www.fieldking.com](http://www.fieldking.com)

DESCRIPTION	FKTRT - 3	FKTRT - 4	FKTRT - 5
Width of Cut Adjustable (mm)	2483	3483	4483
Tyne To Tyne Distance (Adjustable)	1000 (mm)		
No. of Tyres (Optional)	2		
Weight (Kg. Approx.)	200	230	380
Tractor Power (HP)	40-55	60-80	85-105

For more information visit [www.fieldking.com](http://www.fieldking.com)



Shovel is made of EN-42 material



Heavy duty frame



Spring having more capacity of absorbing shock



Tyne is made of EN-9 material



Shovel is made of EN-42 material



Adjustable tynes



Radial tyre depth adjustment



3 Point linkage











Tillage





### Disc Ridger with Roller

DESCRIPTION	FKDRR-1	FKDRR-2
No. of Disc 	2	4
Maximum Width Between Ridgers 	1500 (mm)	
Weight (Kg. Approx.) 	450	1000
Tractor Power (HP) 	50-75	75-110

For more information visit [www.fieldking.com](http://www.fieldking.com)



### Disc Ridger

DESCRIPTION	FKDR-1	FKDR-2
No. of Disc 	2	4
Maximum Width Between Ridgers 	1000 (mm)	
Weight (Kg. Approx.) 	224	435
Tractor Power (HP) 	50-65	70-90

For more information visit [www.fieldking.com](http://www.fieldking.com)



Bearing hub

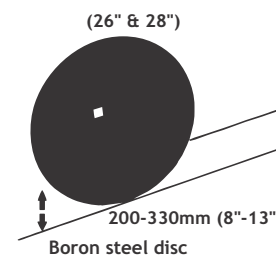

Boron steel disc



Front linkage



Vertical height & cutting angle (Dual angle adjustment)





Telescopic hydraulic cylinder



Corrugated sheet for strength



Detachable drawbar for increased loadability



Brake light reflectors & indicators for safety

Tipping trailers are available in E model & C model with 2 tyres & 4 tyres options.

DESCRIPTION	FKAT2WT-E-2TON	FKAT2WT-E-3TON	FKAT2WT-E-5TON	FKAT2WT-E-9TON	FKAT2WT-E-10TON
Outer Dimensions (mm)	2435 x 1219 x 457	2435 x 1828 x 610	3048 x 1828 x 610	3658 x 1828 x 610	3962 x 2134 x 610
Side Wall Sheet	2/3 mm (Corrugated)		3 mm (Corrugated)		
Tyres	6.00x16, 7.50x16, 9.00x16		7.50 x 16, 9.00 x 16, 12.5/80-15.3 & 400/60-15.5 (14 to 18 PR)		10.00 x 20, 15.0/70-18
Axle (mm)	65/75 Square		75 Square	90 Square	100 Square
Weight (Kg. Approx.)	600	1014	1180	1553	1820
Leaf Spring (Optional)			36"	42"	
Tractor Power (HP)	20-35	30-50	50-70	70-90	90-120

For more information visit [www.fieldking.com](http://www.fieldking.com)



Wider tyres for better stability & gripping



Vertical screw jack for easy parking



Heavy duty axle



Robust hub



Telescopic hydraulic cylinder

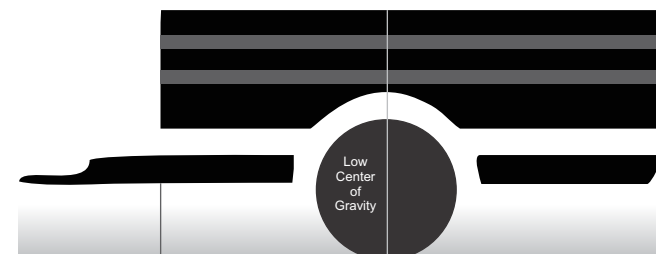





DESCRIPTION	FKAT2WT-E-3TON	FKAT2WT-E-5TON	FKAT2WT-E-9TON
Outer Dimensions	(2435 x 1828 x 610 mm)	(3048 x 1828 x 610 mm)	(3658 x 1828 x 610 mm)
Tyres	7.50 x 16, 9.00 x 16, 12.5/80-15.3 & 400 / 60-15.5 (14 to 18 PR)		
Axle (Brake Optional) (mm)	75 Square		90 Square
Weight (Kg. Approx.)	1265	1580	1900
Leaf Spring (Optional)	36"		42"
Tractor Power (HP)	30-50	50-70	70-90

For more information visit [www.fieldking.com](http://www.fieldking.com)

DESCRIPTION	FKAT4WNT-5T	FKAT4WNT-9T	FKAT4WNT-12T
Outer Dimensions	(3048 x 1828 x 534 mm)	(3658 x 1828 x 610 mm)	(4270 x 2134 x 610 mm)
Tyres	4 nos. of 7.5 x 16		2nos. of 7.5x16, 2nos. of 9.00x16
Axle (mm)	75 Sq. (Front & Rear)		75 Sq.(Front), 90 Sq.(Rear)
Weight (Kg. Approx.)	1550	1720	2000
Tractor Power (HP)	50-70	70-90	90-110

For more information visit [www.fieldking.com](http://www.fieldking.com)



Bob hinge mechanism



Tubular structure Chassis



Corrugated sheet



Safety valve mechanism



Corrugated sheet



Tyre assembly



Ring hitch

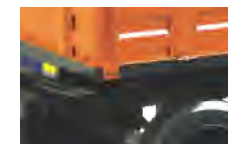

Revolving disc







Laser transmitter



Automated power mast



Tripod & Receiver



Control box

### Laser system

Machine control system to be mounted on tractor consist of :

- 1) Receiver to be mounted on a electric operated power mast directly attached to bucket : High precision:  $\pm 1\text{mm}$  / Normal precision:  $\pm 2\text{mm}$ , Operating temperature:  $-20^{\circ}\text{C}$  /  $-4^{\circ}\text{F}$  to  $+50^{\circ}\text{C}$  /  $122^{\circ}\text{F}$ , Water and dust resistance: IP65
- 2) Power cable for powering system from tractor power (12Volt).
- 3) Cable connecting Control Box (Auto panel) to Valves of tractor for Hydraulic control.

### Laser transmitter unit mounted on tripod consist of :

- 1) Laser transmitter with carrying case. A rugged self leveling laser system with automatic elevation alert, bright red (635nm) beam and a working operating range (Diameter) 700-800 meter Self-leveling Range:  $\pm 3$  degrees, Automatic self-leveling in level & slope mode, Operating temperature:  $-20^{\circ}\text{C}$  /  $-4^{\circ}\text{F}$  to  $+50^{\circ}\text{C}$  /  $122^{\circ}\text{F}$ .

### Eco planer scraper bucket system :

DESCRIPTION	2 Meters	2.5 Meters	3 Meters
Width of Cut (mtr.)	2	2.5	3
Tyre Size	6.00 x 16 (Single/Double), 10.0/75-15.3 & 13/55-16 (Optional)		
Tractor Power (HP)	55-65	70-85	90-105

For more information visit [www.fieldking.com](http://www.fieldking.com)

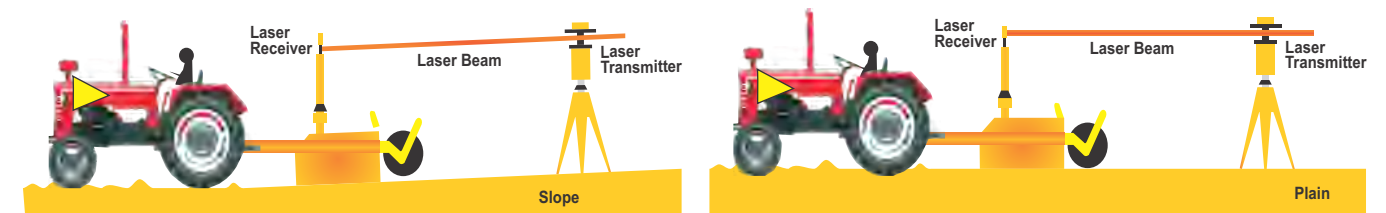





DESCRIPTION	FKRSSTO-6	FKRSSTO-7
Cutting Width (mm)	1590	1940
Gearbox Rating (HP)		75
Weight (Kg. Approx.)	632	712
Tractor Power (HP)	50-75	75-90

For more information visit [www.fieldking.com](http://www.fieldking.com)



Canister

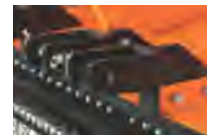

3 Point linkage offset



Chain for safety



Long lasting, wear resistant blades



Tyre assembly for depth control



Chain for safety



Long lasting, wear resistant blades



Cat-I, Cat-II & quick hitch compatibility



Tyre assembly for depth control







DESCRIPTION	FKRC-48	FKRC-60	FKRC-72	FKRC-84
Cutting Width (mm)	1220	1524	1828	2134
Gearbox Rating (HP)	40		75	90
Weight (Kg. Approx.)	222	328	397	555
Tractor Power (HP)	15	25	35	45

For more information visit [www.fieldking.com](http://www.fieldking.com)







DESCRIPTION	FKPHDS - 6	FKPHDS - 9	FKPHDS - 12	FKPHDS - 18
Working Depth (mm) 			890	
Gear Box 	Compatible with 55 HP max., with 3:1 ratio			
Auger Sizes 	6"	9"	12"	18"
Weight (Kg. Approx.) 	133	142	148	179
Tractor Power (HP) 	35-40	40-45	45-50	50-55

For more information visit [www.fieldking.com](http://www.fieldking.com)



Clutch type PTO



Gearbox









Long lasting, wear resistant blades



Long lasting, wear resistant auger tip



DESCRIPTION	FKZSFD-9	FKZSFD-11	FKZSFD-13
No. of Metering Wheels	18	22	26
No. of Seed & Fertilizer Distribution Pipes	18	22	26
No. of Row 	9	11	13
Working Width (mm) 	1410	1760	2110
Seed Tank (Capacity Kg.) 	45	57	69
Fertilizer Tank (Capacity Kg.) 	59	74	89
Weight (Kg. Approx.) 	270	320	370
Tractor Power (HP) 	30-45	50-65	70-85

For more information visit [www.fieldking.com](http://www.fieldking.com)



Seed box & fluted roller



Height adjustable wheel



Seed drill machine tyne





Disc assembly







DESCRIPTION	FKMCP-2	FKMCP-3	FKMCP-4	FKMCP-5	FKMCP-6
Available in	2	3	4	5	6
Seed Metering	Rotating Disc with cells on its periphery.				
Fertilizer Metering	Agitator & Sliding Orifice.				
Row Space	24" max. & adjustable with 'U' Clamps				
Drive	Ground Wheel driven ( Driving wheel is at front in centre of Planter)				
Sowing Depth	Adjustable (Depth Control Wheels are provided on both sides of Planter)				
Furrow Openers	Shovels for sowing in tilled/prepared fields				
Weight (Kg. Approx.) 	140	180	280	330	375
Tractor Power (HP) 	20-25	25-35	35-45	45-60	60-75

For more information visit [www.fieldking.com](http://www.fieldking.com)



Seed & fertilizer box



Driving & depth control wheel





Side shovel



Tyne assembly



DESCRIPTION	FKPMCP-2	FKPMCP-4	FKPMCP-6
Available in Row	2	4	6
Minimum Row Spacing (mm)	304		
Depth for Depth Control Wheel (Max. mm)	102		
Seed Hopper Capacity (Liters)	27 x 2	27 x 4	27 x 6
Fertilizer Hopper Capacity (Liters)	130 x 1	130 x 2	130 x 3
Toolbar Width (mm)	419	2057	3073
Useful Width (mm)	419	2057	3073
Total Width (mm)	419	2057	3073
Weight (Kg. Approx) 	746	1495	2240
Tractor (HP) 	45-50	50-60	60-70

For more information visit [www.fieldking.com](http://www.fieldking.com)



Fertilizer box



Depth adjusting wheel

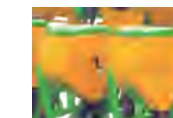

Seed box







DESCRIPTION	FKTMS-550	FKTMS-1100
Capacity (Ltr.)	550	1100
Boom Span (Mtr.)	4/6/8/10/12/14/16	
No. of Nozzles	12/16/20/24/28/32	
Weight of Frame (Kg. Approx.)	162	200
Tractor Power (HP)	50-70	75-90

For more information visit [www.fieldking.com](http://www.fieldking.com)

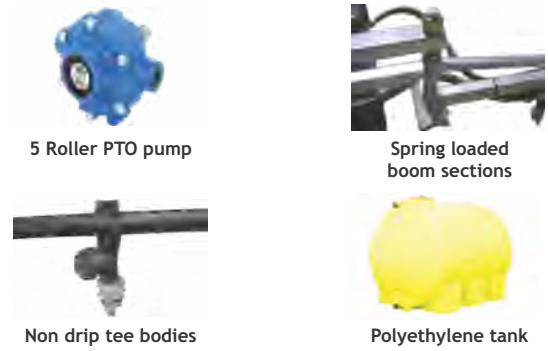

DESCRIPTION	FKFS-180	FKFS-250	FKFS-400
Capacity(Ltr.)	180	250	400
Spreading Capacity	26 ft.5" - 46 ft.		
Transmission	1:1		
Weight (Kg. Approx.)	54	56	60
Tractor Power (HP)	20 (Min)		

For more information visit [www.fielldking.com](http://www.fielldking.com)







DESCRIPTION	FKRFM-5	FKRFM-6
Total Length (mm)	2640	3080
Total Number of Blades	19	25
Cutting Width (mm)	1500	1930
Work Speed (Km/h)	7-10	
P.T.O (RPM)	540	
Weight (Kg. Approx.)	185	200
Tractor Power (HP)	35-50	40-55

For more information visit [www.fieldking.com](http://www.fieldking.com)



Crop guider



Cam mechanism



Blades



Power transmission



DESCRIPTION	FKFCL - SM - 97
Main Boom Tube (mm)	130 x 130 (Square)
Main Boom Length (mm)	4200
Main Boom Width (mm)	1120
Grabber (mm)	1000 x 1000 x 1000
Hydraulic Pump	Rotary Pump - 54.5 Ltr./Sec.
Weight (Kg. Approx.)	1660
Tractor Power (HP)	45-75

For more information visit [www.fieldking.com](http://www.fieldking.com)



Grabber



Hydraulic cylinder



Main boom



Moveable frame







Bale counting meter



Feeding wheel (Optional)



Knotter



Flywheel coupling



DESCRIPTION	SQUARE BALER FKS-511	
Pick-Up Width (m)	1.85	
Bale Chamber (Width x Height) mm	460 x 360	
Bale Length (Smooth Adjustment) (m)	0.3- 1.3	
Pto Shaft Speed (RPM)	540	
No. of Knotter	2	
Binding Twine Capacity	4	
Pick-Up Lifting	Mechanical	
Tires		
RH Standard Tire Size	185R15C	
LH Standard Tire Size	10.0-75/15.3	
Gauge Wheels	Steel Wheel	
Draw Bar Lifting	Mechanical	
Optional Equipment	a) hydraulic moving of the draw bar c) bale chute	b) hydraulic pick-up adjustment d) Feeding Wheel
Dimensions (mm)		
Length	4220	
Width	2430	
Height	1630	
Weight (Kg. Approx.)	1330	
Tractor Power (HP)	35-50	

For more information visit [www.fieldking.com](http://www.fieldking.com)





# The Harvesting Revolution Starts Here!

Presenting Fieldking

# MCH



**FIELDKING**

Multi Crop Harvester



## MULTI CROP HARVESTER



Rice



Wheat



Soybean



Pulses



Corn

Harvest & Post Harvest



DESCRIPTION		FKMCCRH - 2.20
Feeding Capacity (Kg/s)		4
Working Dimension (L x W x H) mm		5150 x 2890 x 2700
Weight (Kg.)		3000
Cabin/Sunshade		Sun Roof
Gear Box	ZKB65	
HST	40CC HST Imported from south Korea	
Grain-unloading Unit	Grain Tank Capacity (m <sup>3</sup> )	1.4
	Grain Discharging Type	All direction discharging pipe
Alarm Units	Water temperature, Battery, Oil, Grain Tank	
Harvesting Efficiency (Acre/Per Day)	8-14	
Crops	Rice, Wheat, Cole, Corn	

For more information visit [www.fieldking.com](http://www.fieldking.com)



Specially designed powerful 88hp engine



Reliable parts design and higher operating efficiency of thresher



Specially designed engine air ventilation with cooling radiator

Engine	Engine	Vertical, Water-cooling, 4x4 Inject, Turbocharger
	Displacement (L[cc])	2.980 [2980]
	Power/Speed (ps[Hp]/rpm)	88/2600
	Fuel	Light Diesel Oil
	Fuel Capacity (L)	115
	Fuel Consumption (Kg./hm <sup>2</sup> )	17-29
	Start	Motor Starter

Harvesting Unit	Grain Lifter	Divider	
	Reel Bat	Dia. X Length (mm)	∅ 900 x 2028
		Adjusting Means	Hydraulic
	Working With (mm)		2200
	Stubble Height [Lift]		40cm or above
Fallen Crop (Angle)		Flow: Less than 85° Reverse less than 70°	
Threshing Unit	Threshing Mode	Axial Flow Type, Bullet Rotor	
	Threshing Rotor	Type of Threshing	Beat Bar
		Dia. x Length (mm)	∅ 620 x 2010
		Rotating Speed (rpm)	560 / 600
	Separating Type		Vibrating Screen. Air Separating (3Air Blows)
Area of Sieves (Lower and Upper Sieves) (m <sup>2</sup> )		1.645	



Single maneuvering lever makes machine easy to operate



Different RPM of reel (35, 38, 41, 45). Easy to change single belt



Quick 340° rotating grain discharge auger & hydraulic operated vertical height adjustment

Walking Part	Rubber Track	Length of Ground Contact (mm)	1700
		Center Distance (mm)	1160
		Size (mm)	450 x 90 x 51
		Average Contact Pressure (kpa[kgf]/cm <sup>2</sup> )	20 Kpa
	Min. Ground Clearance (mm)		300
	Walk	Forward (Km/H)	Low:0-0.97, Medium:0-1.85, High:0-2.5
	Speed	Reverse (Km/H)	



Straw anti-winding design of Rubber Track for good performance in paddy field



Higher ground clearance (300mm)





Double oil cylinder header assembly for better stability







DESCRIPTION	FKHR-Z-510
Working Width of Tedding (mm)	2300
Working Width of Raking (mm)	1500
Number of Raking Wheels	4
Weight (Kg. Approx.) 	122
Tractor Power (HP) 	25-35

For more information visit [www.fieldking.com](http://www.fieldking.com)



Frame



Raking Wheel



Drawbar



Wheel



Heavy Duty Cultivator



Beri Type Spring Loaded Cultivator



Water Tanker



Terracer Blade



Heavy Duty Land Leveler



Box Blade



Bale Spears



Fixed Mould Board Plough







Product Demo



Product Packaging



Dealer & Customer meet



Store Standardization



Road Shows & Service Camps



39 Years of excellence  
6 Continents  
97 Countries  
1 Team  
Over 1.2 million satisfied farmers  
& Counting...

